

# GP700 GRINDER

# INSTRUCTION MANUAL



Read Manual Before Operating Machine



# Table of Contents

---

<b>Features and Specifications</b> .....	<b>4</b>
<b>Safety</b> .....	<b>5</b>
<b>Operation</b> .....	<b>7</b>
Tooling Installation .....	7
Adjustable Handle.....	7
Start-Up Procedure.....	7
Controller .....	8
<b>Maintenance</b> .....	<b>9</b>
Lubricating the Machine.....	9
Keeping Machine Clean.....	9
Replacing Worn, Damaged, Missing Parts .....	9
High Motor Temperature .....	9
Tooling Installation and Replacement.....	10
Accessing the Drive Plate, Drive Key, and Grease Seal .....	10
<b>Parts List and Diagrams</b> .....	<b>11</b>
<b>Warranty</b> .....	<b>15</b>

# Features and Specifications



## FEATURES

**Manual foot leveling device** - Improved machine control, faster and greater range of adjustments (6 leveling adjustments in 1/8" increments), and simple to operate.

**Lightweight machine** - For ease of transportation, yet has sufficient abrasive pressure by use of the removable weights.

**Adjustable handle** - 10 positions of adjustment.

Product Specifications				
Width	Length	Height	Weight	Input Voltage / Amp Draw
29.5" (749 cm)	72.25" ( 1,835 cm)	52" (1,321 cm)	1,425 lbs (646 kg)	3-Phase 230 V / 23 A

# Safety

## GENERAL RULES FOR SAFE OPERATION

Before use, anyone operating or performing maintenance on this equipment must read and understand this manual, as well as any labels packaged with or attached to the machine and its components. Read the manual carefully to learn equipment applications and limitations, as well as potential hazards associated with this type of equipment. Keep manual near machine at all times. If your manual is lost or damaged, contact National Flooring Equipment (NFE) for a replacement.

### Personal

#### **Dress properly and use safety gear.**

Do not wear loose clothing; it may be caught in moving parts. Anyone in the work area must wear safety goggles or glasses, hearing protection during extended use, and a dust mask for dusty operations. Hard hats, face shields, safety shoes, etc. should be worn when specified or necessary.

#### **Maintain control; stay alert.**

Keep proper footing and balance, and maintain a firm grip. Observe surroundings at all times and use common sense. Do not use when tired, distracted, or under the influence of drugs, alcohol, or any medication that may cause decreased control.

#### **Keep hands away from all moving parts and tooling.**

Wear gloves when changing tooling. Remove tooling when machine is not in use and/or lower cutting head to the floor.

#### **Do not force equipment.**

Equipment will perform best at the rate for which it was designed. Excessive force only causes operator fatigue, increased wear, and reduced control.

### Environment

#### **Avoid use in dangerous environments.**

Do not use in rain, damp or wet locations, or in the presence of explosive atmospheres (gaseous fumes, dust, or flammable materials). Remove materials or debris that may be ignited by sparks. Keep work area tidy and well-lit - a cluttered or dark work area may lead to accidents. Extreme heat or cold may affect performance.

#### **Protect others in the work area and be aware of surroundings.**

Provide barriers or shields as needed to protect others from debris and machine operation. Children and other bystanders should be kept at a safe distance from the work area to avoid distracting the operator and/or coming into contact with the machine. Operator should be aware of who is around them and their proximity. Support personnel should never stand next to, in front of, or behind the machine while the machine is running. Operator should look behind them before backing up.

#### **Guard against electric shock.**

Ensure that machine is connected to a properly grounded outlet. Prevent bodily contact with grounded surfaces, e.g. pipes, radiators, ranges, and refrigerators. When scoring or making cuts, always check the work area for hidden wires or pipes.

### Maintenance & Repairs

#### **Begin maintenance work only when the machine is shut down, unplugged, and cooled down.**

#### **Use proper cleaning agents.**

Ensure that all cleaning rags are fiber-free; do not use any aggressive cleaning products.

#### **Schedule regular maintenance check-ups.**

Ensure machine is properly cleaned and serviced. Remove all traces of oil, combustible fuel, or cleaning fluids from the machine and its connections and fittings. Retighten all loose fittings found during maintenance and repair work. Loose or damaged parts should be replaced immediately; use only NFE parts.

#### **Do not weld or flame-cut on the machine during repairs, or make changes to machine without authorization from NFE.**

### Equipment

#### **Use proper parts and accessories.**

Only use NFE-approved or recommended parts and accessories. Using any that are not recommended may be hazardous.

#### **Ensure accessories are properly installed and maintained.**

Do not permanently remove a guard or other safety device when installing an accessory or attachment.

#### **Inspect for damaged parts.**

Check for misalignment, binding of moving parts, loose fasteners, improper mounting, broken parts, and any other conditions that may affect operation. If abnormal noise or vibration occurs, turn the machine off immediately. Do not use damaged equipment until repaired. Do not use if power switch does not turn machine on and off. For all repairs, insist on only identical NFE replacement parts.

#### **Maintain equipment and labels.**

Keep handles dry, clean, and free from oil and grease. Keep cutting edges sharp and clean. Follow instructions for lubricating and changing accessories. Motor and switches should be completely enclosed at all times with no exposed wiring. Inspect cord regularly. Labels carry important information; if unreadable or missing, contact NFE for a free replacement.

#### **Avoid accidental starting; store idle equipment.**

When not in use, ensure that the machine is unplugged and breaker is set to OFF. Store in a dry, secured place. Remove tooling when storing, and keep away from children.

# Safety

## GRINDER SAFETY GUIDELINES

Before use, anyone operating this equipment must read and understand these safety instructions.

### Grinding

#### Beware of hidden obtrusions.

Watch out for hidden dangers and protrusions in flooring. Do not use on largely uneven surfaces.

#### Avoid contact with hot tooling and shroud.

Do not touch the tooling or shroud without proper hand protection. Both become hot during operation and remain hot after stopping the machine.

#### Use correct tooling and accessories.

Provide barriers or shields as needed to protect others from debris.

#### Use for correct applications.

Do not force equipment to do heavier duty work than it was made for.

#### Do not block the machine's air flow.

Blocking ventilation slots or air flow will result in damage to the machine. Leave space for air to flow freely during operation.

#### Use dead man cable during operation.

Loss of control of the grinder could cause damage, injury, or death.

### Dust Collection

#### Use with appropriate dust collecting system.

Do not operate machine designed for use with a dust collector without the dust collector. Ensure dust collector is on and operating properly while grinding.

#### Use with appropriate dust collection hose.

Do not operate the machine without the hose securely attached to the inlet of the dust collector and the outlet of the grinder. In order to maintain system efficiency, do not use a damaged hose.

#### Dispose of collected waste before, during, and after use.

Do not leave the dust collector bag full of waste. Handle and dispose of bag and waste in accordance with all applicable local, state, and federal regulations. Dispose of waste prior to transport.

### Battery (Propane Machines Only)

#### Remove personal metal items when working with battery.

A battery can produce a short circuit current sufficient enough to weld metal objects, causing severe burns. Be careful to not drop metal tools on the battery, as a spark or short circuit could cause an explosion.

#### Never smoke or allow a spark or flame near the battery.



**WARNING:** BE CAUTIOUS WHEN WORKING WITH BATTERY. IF ELECTROLYTIC ACID GETS IN THE EYES, IMMEDIATELY FLUSH OUT WITH COLD, FRESH WATER FOR AT LEAST 10 MINUTES AND GET MEDICAL HELP.

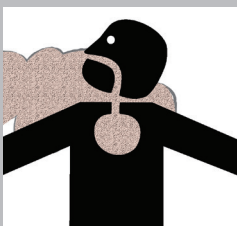

**WARNING:** GRINDING/CUTTING/DRILLING OF MASONRY, CONCRETE, METAL AND OTHER MATERIALS CAN GENERATE DUST, MISTS AND FUMES CONTAINING CHEMICALS KNOWN TO CAUSE SERIOUS FATAL INJURY OR ILLNESS, SUCH AS RESPIRATORY DISEASE, CANCER, BIRTH DEFECTS OR OTHER REPRODUCTIVE HARM. IF YOU ARE UNFAMILIAR WITH THE RISKS ASSOCIATED WITH THE PARTICULAR MATERIAL BEING CUT, REVIEW THE MATERIAL SAFETY DATA SHEET AND/OR CONSULT YOU EMPLOYER, THE MATERIAL MANUFACTURER/SUPPLIER, GOVERNMENTAL AGENCIES SUCH AS OSHA AND NIOSH AND OTHER AUTHORITIES ON HAZARDOUS MATERIALS. CALIFORNIA AND SOME OTHER AUTHORITIES, FOR INSTANCE, HAVE PUBLISHED LISTS OF SUBSTANCES KNOWN TO CAUSE CANCER, REPRODUCTIVE TOXICITY, OR OTHER HARMFUL EFFECTS. CONTROL DUST, MIST AND FUMES AT THE SOURCE WHERE POSSIBLE. IN THIS REGARD USE GOOD WORK PRACTICES AND FOLLOW THE RECOMMENDATIONS OF THE MANUFACTURER/SUPPLIER, OSHA/NIOSH, AND OCCUPATIONAL AND TRADE ASSOCIATIONS. WHEN THE HAZARDS FROM INHALATION OF DUST, MISTS AND FUMES CANNOT BE ELIMINATED, THE OPERATOR AND ANY BYSTANDERS SHOULD ALWAYS WEAR A RESPIRATOR APPROVED BY OSHA/MSHA FOR THE MATERIAL BEING CUT.

## TOOLING INSTALLATION

1. Remove weights.
2. Raise adjustable handle as far forward as possible; lock into position and put one foot on the rubber-tired wheel.
3. Tip the machine back to the floor so that the handle lays on the floor.
4. Clean mounting surface; slide the diamond into the holder (Figure 1) and tap into place.
5. After the diamonds are installed, raise the machine until it is in operating position with all tooling touching the floor.
6. Lower handle to position best suited for the operator, and re-place the weights.



FIG. 1

## Directional Tooling Placement

When looking at the machines from the bottom (Figure 2), the directional tooling marked “Right” should be placed on the heads that rotate counterclockwise. Tooling marked “Left” should be placed on the heads that rotate clockwise.

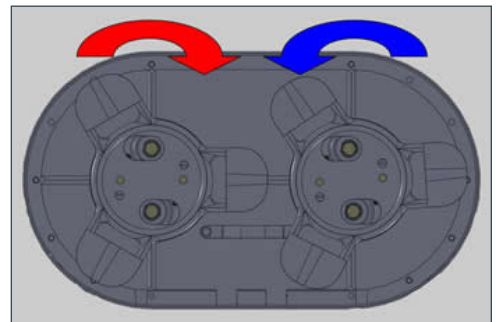

FIG. 2

## ADJUSTABLE HANDLE

The adjustable handle is very easy to operate.

1. Unscrew the safety knob
2. Push knob to the rear to release the locking mechanism.
3. When you have raised or lowered the handle to your desired position, push knob forward as far as you can and screw the safety knob tight. This will lock the handle in position.

## START-UP PROCEDURE

1. Ensure plug is connected properly to the power source.
2. Ensure dust hose is connected correctly to dust collector and machine.
3. Check that the main switch is turned on and the dead man switch is in place, with the lanyard around the operator’s wrist.
4. Place downward pressure on handle; press the “Run” button.
5. Release pressure from handle and immediately begin moving the machine from side-to-side to prevent the tools from digging into the concrete surface and creating an uneven profile. When grinding in work area is complete, push the “Stop” button.

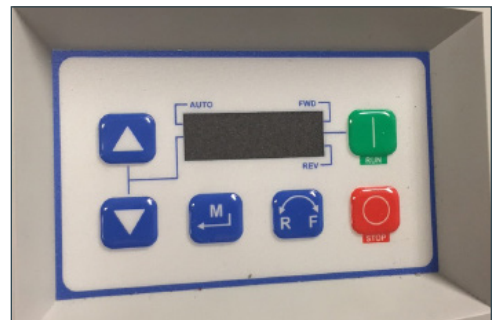

FIG. 3

## CONTROLLER

### Operating Controls (Figure 3)

**Run / Stop** - Pushing the “Run” button will turn the controls on and start the motor. Pushing the “Stop” button will stop the motor.

**Up / Down Arrows** - While powered on but without the motor running, the up and down arrow buttons can be used to set the motor speed faster or slower than the base RPM of the motor, or to move through the menu.

**Forward/Reverse** - Pushing the “R/F” button will change the tooling rotation direction.

**“Dead Man” Key** - The “dead man” key is located in the lower center of the red box, and is intended to be used for the safety of the operator and protection of the machine from

# Operation

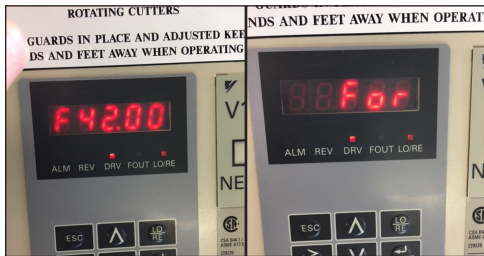

FIG. 4



FIG. 5



FIG. 6



FIG. 7



FIG. 8



FIG. 9



FIG. 10



FIG. 11



FIG. 12



FIG. 13



FIG. 14

excess damage in the event of an emergency. Lanyard must be worn by operator for this safety device to work properly. Pull key out to stop the machine motor.

## Controller Settings

Below is a list of settings that the operator can scroll through on the controller, in order of appearance. Press up/down arrows until the desired parameter is shown.

- "Fxx.xx" is the input frequency used to adjust tooling RPM (Figure 4).
- "For" or "rEv" is used for changing the rotational direction of the tooling to forward or reverse (Figures 5 and 6).
- "0.00" is the output frequency setting (Figure 7).
- "0.0A" is the output current draw (Figure 8).
- "0.0v" is the voltage output to the motor (Figure 9).

The following settings should not be selected or used by the operator:

- "Mon" monitor display (Figure 10).
- "vrFY" verify menu (Figure 11).
- "STUP" setup mode (Figure 12).
- "PA" parameter setting mode (Figure 13).
- "ATUn" auto-tuning (Figure 14).

## Input Frequency Setting

The input frequency (Figure 4) can be used as follows to adjust tooling RPM:

1. Press the up/down arrows until "Fxx.xx" is shown, where xx.xx is some number.
2. Press "Enter;" the first digit will flash.
3. Press the up/down arrows until the desired number is shown for the first digit.
4. To change any other digit, use the ">" key to select the digit, then press the up/down arrows until the desired number is shown in that position.
5. Press "Enter" then press "Esc."

## Setting the Tooling Rotational Direction

To set tooling rotational direction (Figures 5 and 6) to forward or reverse, complete the following steps:

1. Press the up/down arrows until "For" or "rEv" is shown.
2. Press "Enter;" the letters will flash.
3. Press the up/down arrows until the desired rotational direction is shown.
4. Press "Enter;" then press "Esc."

## LUBRICATING THE MACHINE

### Main Gear Case

- The main gear case contains 6-1/4 pounds of grease.
- Gear case level should be checked once a year. The level of the grease in the gear case should be up to half the thickness of the helical gears.

### Wheel Bearings

Use grease gun and grease every six months, 1 shot of grease on each wheel.

### Other Grease Fittings

- Two fittings on bearing caps on top of gear case. Lubricate these fittings every six months with 3 shots of grease.
- One fitting on foot leveling device; recommended grease every six months with 1/2 shot of grease.
- There are four shoulder bolts located at the pivot points of the handle bar that require 1/2 shot of grease every six months.

## KEEPING MACHINE CLEAN

Schedule daily cleaning after each days grinding. Do not let any cake-up of cement grinding paste occur, as this could create an overload on your machine.

1. Tilt machine back on handle
2. Clean under carriage with water using a garden hose and nozzle.
3. Clean all grease fittings.

## REPLACING WORN, DAMAGED, MISSING PARTS

### Morflex Couplings

- Bolts should be checked weekly for tightness. Loose bolts cause extreme vibrations and premature failure of rubber inserts in the couplings.
- Flexible couplings should be changed a minimum of once a year whether you use your machine or not.



**WARNING:** IF WORN OR DAMAGED PARTS (BEARINGS, GEARS, ETC.) ARE NOT REPLACED PROMPTLY, DAMAGE TO THE MACHINE COULD OCCUR.

## HIGH MOTOR TEMPERATURE

- "Running Hot" is normal for the smaller, lighter "T" type motor. Even though they will run hotter, the "T" motors run more efficiently on this machine.
- Electric motors on this machine are designed to operate efficiently at 165°F (74°C).
- The temperatures of motors are rated by temperature rise and full load over and above room temperature (25°C or 77°F).
- Do not touch the motors while they are hot. To check the temperature of the motor, place a 200°F thermometer on the frame of the motor and a glob of putty over the bulb of the thermometer.
- A thermal protected starter is used on these machines, which protects the motor against low voltage and overload conditions which could raise the temperature of the motor beyond safe limits.

# Maintenance

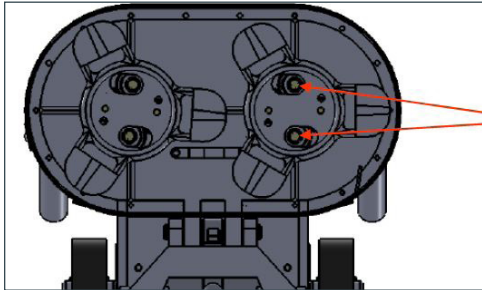

FIG. 15

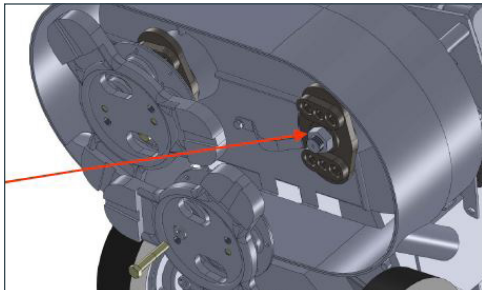

FIG. 16

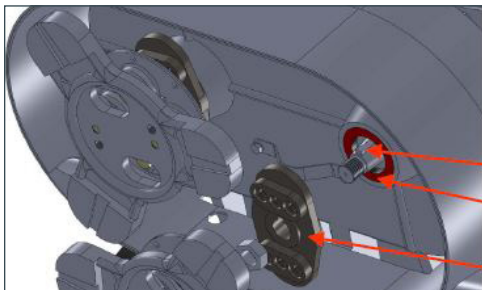

FIG. 17

## TOOLING INSTALLATION AND REPLACEMENT

Check diamonds for wear periodically, as they may be worn flush with the holder lugs.

1. Move the counterbalancing weights to the upper weight baskets.
2. Using the flop handle, tilt machine back so that the caster wheel rests on the floor.
3. Clean mounting surface on both the diamond and holder. On 2" or 3" diameter diamond, push into the hole and twist slightly to be certain it is securely in place.
4. Grasp machine handle and lower machine to the floor slowly so that all diamonds are resting on the floor. Make certain none have fallen or loosened while lowering the machine to the floor.

## ACCESSING THE DRIVE PLATE, DRIVE KEY, AND GREASE SEAL

- Remove tool plate and coupling by removing two 3/4" bolts (Figure 15).
- Remove the drive plate by removing 1-7/16" lock nut (Figure 16).

### Replacing a Damaged Key

If the drive plate won't spin, the key is likely damaged. Complete the above steps to gain access to the key and check for damage (Figure 17). Replace if damaged or contact NFE for further assistance.

# Parts List and Diagrams

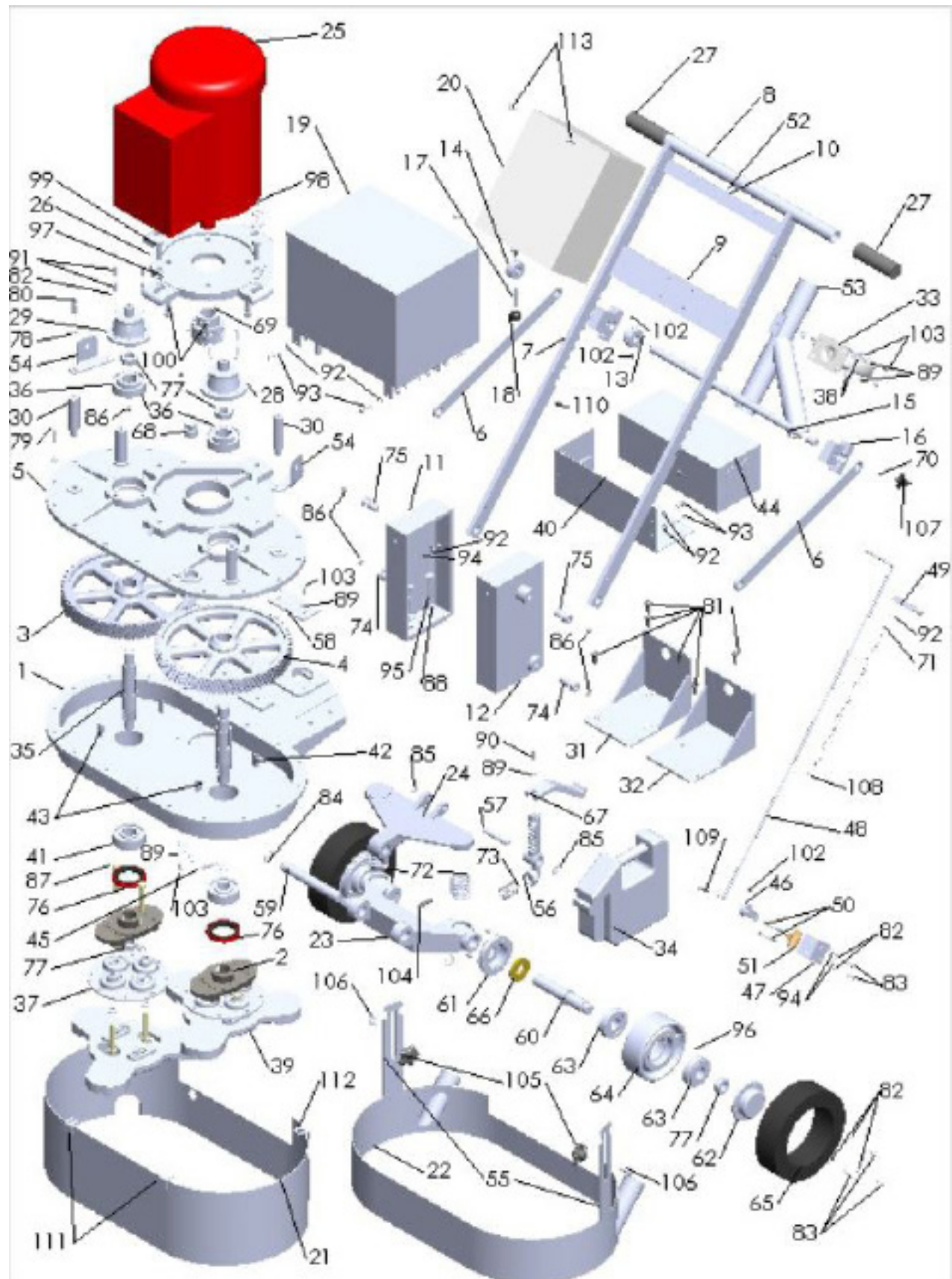

# Parts List and Diagrams

ITEM NO.	DESCRIPTION	QTY.	ITEM NO.	DESCRIPTION	QTY.
1	GEAR CASE	1	38	CASTER WHEEL	1
2	DRIVE SPIDER (403628)	2	34	POCKET WEIGHT	4
3	HELICAL GEAR LH	1	35	HELICAL GEAR SHAFT	2
4	HELICAL GEAR RH	1	36	BEARING CONE, BEARING CAP	2
5	GEAR CASE COVER	1	37	MORFLEX COUPLING (403627)	2
6	STOP SLIDE BAR	2	38	FLAT WASHER	4
7	HANDLE BAR SLOTTED RAIL	2	39	SPEED SHIFT TOOL PLATE	2
8	HANDLE BAR TUBE	1		PLUG STONE TOOL PLATE	2
9	LOWER SWITCH BOX BRACKET	1		UNIVERSAL TOOL PLATE	2
10	UPPER SWITCH BOX BRACKET	1	40	BOOSTER BOX HOLDER	1
11	HANDLE BRACKET RH	1	41	BEARING CONE, BEARING CAP	2
12	HANDLE BRACKET LH	1	42	HELICAL GEAR KEY	2
13	INDICING STOP	1	43	WOODRUFF KEY (403629)	2
14	COLLAR	1	44	TRANSFORMER	1
15	POSITIONING ROD	1	45	WATER HOSE BRACKET	1
16	HANDLE SLIDE BLOCK	2	46	WATER VALVE LEVER	1
17	STUD	1	47	MOUNTING CLAMP	1
18	PLASTIC ENDS	1	48	WATER TANK LEVER	1
19	WATER TANK-STAINLESS	1	49	HANDLE GUIDE	1
20	MAGNETIC STARTER	1	50	WATER VALVE CLAMP	2
	VARIABLE SPEED DRIVE	1	51	WATER TANK VALVE	1
21	STATIONARY GUARD-MILD	1	52	HEX NUT	4
	STATIONARY GUARD-STAINLESS	1	53	Y-PIPE (DRY ONLY)	1
22	DRY GUARD ASSEMBLY	1	54	GUARD BRACKET	2
23	LOWER CARRIAGE BRACKET	1	55	GUARD STRAP	2
24	UPPER CARRIAGE BRACKET	1	56	FOOT PEDAL ARM	1
25	7.5 HP, 1 PH, 200 V, 60 Hz MOTOR	1	57	PIN	1
	7.5 HP, 3 PH, 240/415 V, 60 Hz	1	58	CARRIAGE PLATE	1
	7.5 HP, 3 PH, 230 V, 60 Hz	1	59	PIN	1
	7.5 HP, 1 PH, 230 V, 60 Hz	1	60	TRUCK WHEEL SHAFT	2
	3 HP, 1 PH, 200 V, 30 Hz	1	61	INNER BEARING CAP	2
26	MOUNTING PLATE	1	62	OUTER BEARING CAP	2
27	HANDLE GRIP	2	63	BEARING CUP, BEARING CONE	4
28	BEARING CAP-RH	1	64	TRUCK WHEEL	2
29	BEARING CAP-LH	1	65	TRUCK WHEEL TIRE	2
30	RISER PIN	4	66	TRUCK WHEEL FELT WASHER	2
31	WEIGHT BASKET-LH	1	67	FOOT PEDAL	1
32	WEIGHT BASKET-RH	1	68	GREASE PLUG	1

404824

# Parts List and Diagrams

ITEM NO.	DESCRIPTION	QTY.	ITEM NO.	DESCRIPTION	QTY.
69	7.5 HP PINION	1	P1	CAPSCREW	8
	5 HP PINION	1	P2	FLAT WASHER	15
70	LOCK COLLAR	3	P3	CAPSCREW	7
71	COMPRESSION SPRING	1	P4	HEX NUT	9
72	UNDER CARRIAGE SPRING	2	P5	CAPSCREW	4
73	UNDER CARRIAGE SPRING	1	P6	GREASE ZERK	2
74	SHOULDER BOLT	2	P7	WROUGHT FLAT WASHER	4
75	SHOULDER BOLT	2	P8	CAPSCREW	1
76	GREASE SEAL (403630)	1	P9	CAPSCREW	3
77	NYLON LOCK NUT	6	100	CAPSCREW	4
78	LOCK WASHER	2	101	SET SCREW	1
79	CAPSCREW	1	102	SET SCREW	3
80	CAPSCREW	5	103	CAPSCREW	9
81	SOCKET FLAT HEAD	6	104	SET SCREW	1
82	LOCK WASHER	22	105	GUARD KNOB	2
83	FLUSTER HEAD	14	106	CARRIAGE BOLT	2
84	SNAP RING	2	107	HANDLE BAR KNOB	1
85	SNAP RING	2	108	HANDLE SPACER COLLAR	1
86	GREASE ZERK	7	109	COTTER PIN	1
87	CAPSCREW	5	110	DOWEL PIN	2
88	LOCK WASHER	16	111	GUARD BRACKET	2
89	LOCK WASHER	10	112	LONG GUARD BRACKET	2
90	CAPSCREW	1	113	SLOTTED TRUSS HEAD SCREW	4

## NOT PICTURED

DESCRIPTION	QTY.
10-3 CABLE (801-S)	100'
8-3 CABLE (701-S)	100'
MALE PLUG, 30A, 1 PH (801-S)	2
CONNECTOR, 30A, 1 PH (801-S)	2
MALE PLUG, 30A, 1 PH (701-S)	2
FEMALE PLUG, 30A, 1 PH (701-S)	2
MALE PLUG, 30A, 3 PH (701-S)	2
FEMALE PLUG, 30A, 3 PH (701-S)	2
VACUUM HOSE	
BRUSH STRIP (403633)	
DUST SEAL (403616)	1
EMERGENCY STOP	1
START/STOP (MAGNETIC ONLY)	1

LABEL, 208/230V, 3-PHASE ONLY (403715) 1

PLUG, MALE, HUBBELL TWIST LOCK, 3P4W, 50A 3PH 250V AC (403754) 1

PLUG, FEMALE, HUBBELL TWIST LOCK, 3P4W, 50A 3PH 250V AC (403753) 1





# Warranty

---

National Flooring Equipment Inc. (referred to as "the Company") warrants that each new unit manufactured by The Company, to be free from defects in material and workmanship in normal use and service for a period of twelve (12) months from date of shipment from the Company. For administrative ease, will honor warranty for a period of fifteen (15) months from date of shipment from the company. Accessories or equipment furnished and installed on the product by the Company but manufactured by others, including but not limited to: engines, motors, electrical components, transmissions etc., shall carry the accessory manufacturers own warranty. Battery warranties are prorated over the warranty period. Customer is responsible for the inspection of equipment / parts upon delivery. Freight damages reported beyond authorized time frame will not be honored.

The Company, at its determination of defect, will repair or replace any product or part deemed to be defective in material or workmanship within specified warranty time period. All product determinations and / or repairs will take place at the designated Company repair facility, or at a certified warranty location designated by the Company. The Company will coordinate and be responsible for all freight expenses associated with valid warranty claims. Freight and shipping expenses associated with abuse or misuse will be back charged to the Distributor/Customer. The Company reserves the right to modify, alter or improve any part / parts without incurring any obligation to replace any part / parts previously sold without such modified, altered or improved part / parts. In no event shall the seller or manufacturer of the product be liable for special, incidental, or consequential damages, including loss of profits, whether or not caused by or resulting from the negligence of seller and / or the manufacturer of the product unless specifically provided herein. This warranty shall not apply to any products or portions there of which have been subjected to abuse, misuse, improper installation or operation, lack of recommended maintenance, electrical failure or abnormal conditions and to products which have been tampered with, altered, modified, repaired, reworked by anyone not approved or authorized by the Company or used in any manner inconsistent with the provisions of the above or any instructions or specifications provided with or for the product. Any and all unauthorized onsite warranty work conducted by unauthorized personnel or any outside person(s), is not covered by the Company unless the work has been pre-authorized by a predetermined manufacturer representative. This excludes wearable parts and/or consumables.

Defective or failed material or equipment shall be held at the purchaser's premises until authorization has been granted by the Company to return or dispose of defective products. Products returned for final inspection must be returned with a manufacturer authorized Return Material Authorization (RMA). Any unauthorized return of equipment will be declined at the dock by the Company. Any non-approved items returned with approved returned items are subject to rejection and will not be credited. Credit will be issued for material found to be defective upon the Company's inspection based on prices at time of purchase.

**TO OBTAIN SERVICE CONTACT NATIONAL FLOORING EQUIPMENT, INC. TOLL FREE AT 800-245-0267 FOR A REPAIR AUTHORIZATION NUMBER. COD FREIGHT RETURNS WILL NOT BE ACCEPTED. FREIGHT COLLECT SHIPMENTS WILL NOT BE ACCEPTED. WARRANTY REPAIRS MUST BE ACCOMPANIED BY DATE OF PURCHASE RECEIPT AND A RETURN/ REPAIR AUTHORIZATION NUMBER.**

**RETURN/REPAIR AUTHORIZATION NUMBER:** \_\_\_\_\_

**MACHINE SERIAL NUMBER:** \_\_\_\_\_



9250 Xylon Avenue N • Minneapolis, MN 55445 • U.S.A.  
Toll-free 800-245-0267 • Phone 763-315-5300 • Fax 800-648-7124 • Fax 763-535-8255  
Web Site: [www.nationalequipment.com](http://www.nationalequipment.com) • E-Mail: [info@nationalequipment.com](mailto:info@nationalequipment.com)